

## **Bathroom Vanitie**

# Contents

## Before Use

General Guidelines.....	03
Warning.....	03
Material Properties.....	03

## Installation Guide

Assembly Instructions.....	03
Parts List.....	04
Accessories List.....	05
Exploded Views.....	06
Installation Steps.....	08

## Operation

Use and Maintenance.....	15
Trouble Shooting.....	16

## General Guidelines

- Please read the following instructions carefully and use the product accordingly.
- Please keep this manual and hand it over when you transfer the product.
- Product is intended for indoor use only. It must be assembled and used according to the instructions. The seller does not accept any responsibility for damage or injury resulting from improper assembly or use.
- This summary may not include every detail of all variations and considered steps.
- Please contact us when further information and helps are needed.

## Warning

- Children are not allowed to assemble the product. During assembly, keep any small part out of reach of children as they may be fatal if swallowed or inhaled.
- Children are not allowed to stand, climb or play on the product to avoid serious bodily injury by the toppling.
- Keep plastic packing bags out of reach of children to avoid any potential danger, such as suffocation.
- Avoid sharp objects and corrosive chemicals to prevent damage to the product or bodily injury.

## Material Properties

### 1. Solid Wood

Trees will have a unique texture, scar, color and other natural marks during their growth. These elements constitute the natural beauty of wood. After being made into furniture, there will be slight discoloration when viewed under different light and different angles. That is because different grain minerals and light intensity affect vision, which is a normal phenomenon.

### 2. Marble and Sintered Stone

The pattern of marble and sintered stone is unique to each piece. Due to the characteristics of the material, there is no guarantee that the pattern of each piece will be consistent with the pattern seen at the time of purchase.

## Assembly Instructions

- Read these instructions carefully and keep for future reference. Refer to parts inventory for guidance, and ensure you have all pieces before starting.
- **When assembling place all parts on a soft, clean, and flat surface such as a carpet to prevent scratches.**
- **During assembly, align all screws with the corresponding pre-drilled holes first and then tighten them one by one.**



TIME



2 People



DIFFICULTY

Do not discard any contents until after assembly is complete to avoid accidentally discarding small parts or hardware.

### TOOLS YOU MAY NEED

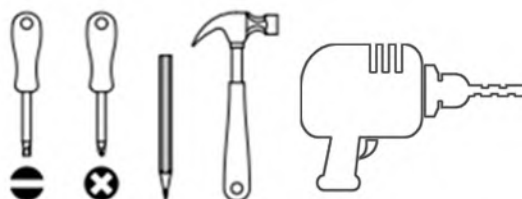





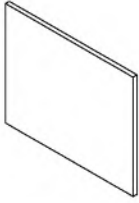
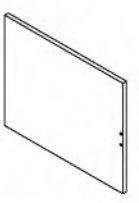
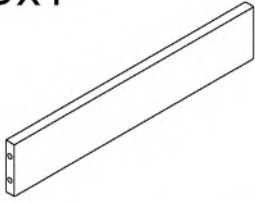
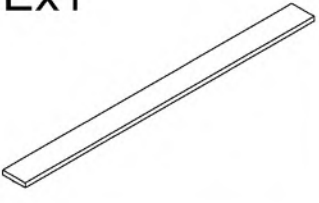
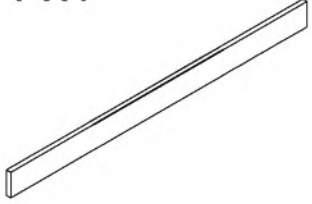
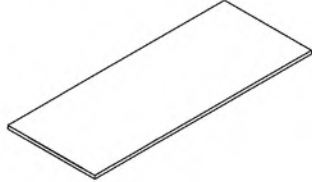
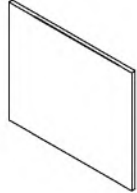
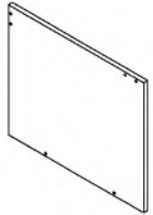
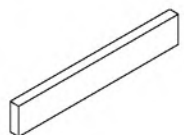
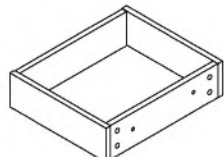
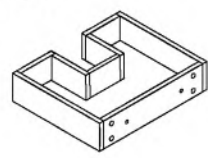
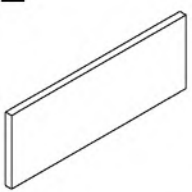
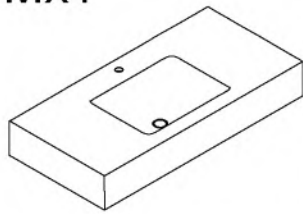
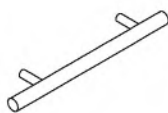
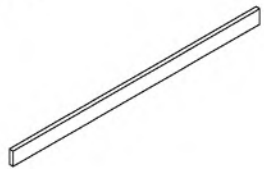







Note: It is recommended that installation of the product be done by a qualified licensed furniture assembler.

# Parts List

Ax1 	Bx1 	Dx1 	Ex1 
Fx1 	Gx1 	Hx1 	Ix1 
Jx2 	K1x1 	K2x1 	Lx2 
Mx1 	Px2 	Rx1 	

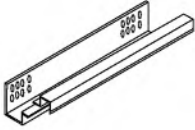
# Accessories List

<p>AAx32</p> 	<p>BBx32</p> 	<p>CCx4</p>  <p>M6*25mm</p>	<p>DDx20</p>  <p>M4*15mm</p>
<p>EEx4</p> 	<p>FFx6</p> 	<p>HHx4</p> 	<p>IIx2</p> 
<p>JJx2</p> 	<p>KKx4</p> 	<p>LLx4</p> 	<p>MMx12</p>  <p>M3.5*14mm</p>
<p>OOx4</p>  <p>M4*18mm</p>			

# Exploded Views

## EXPLODED

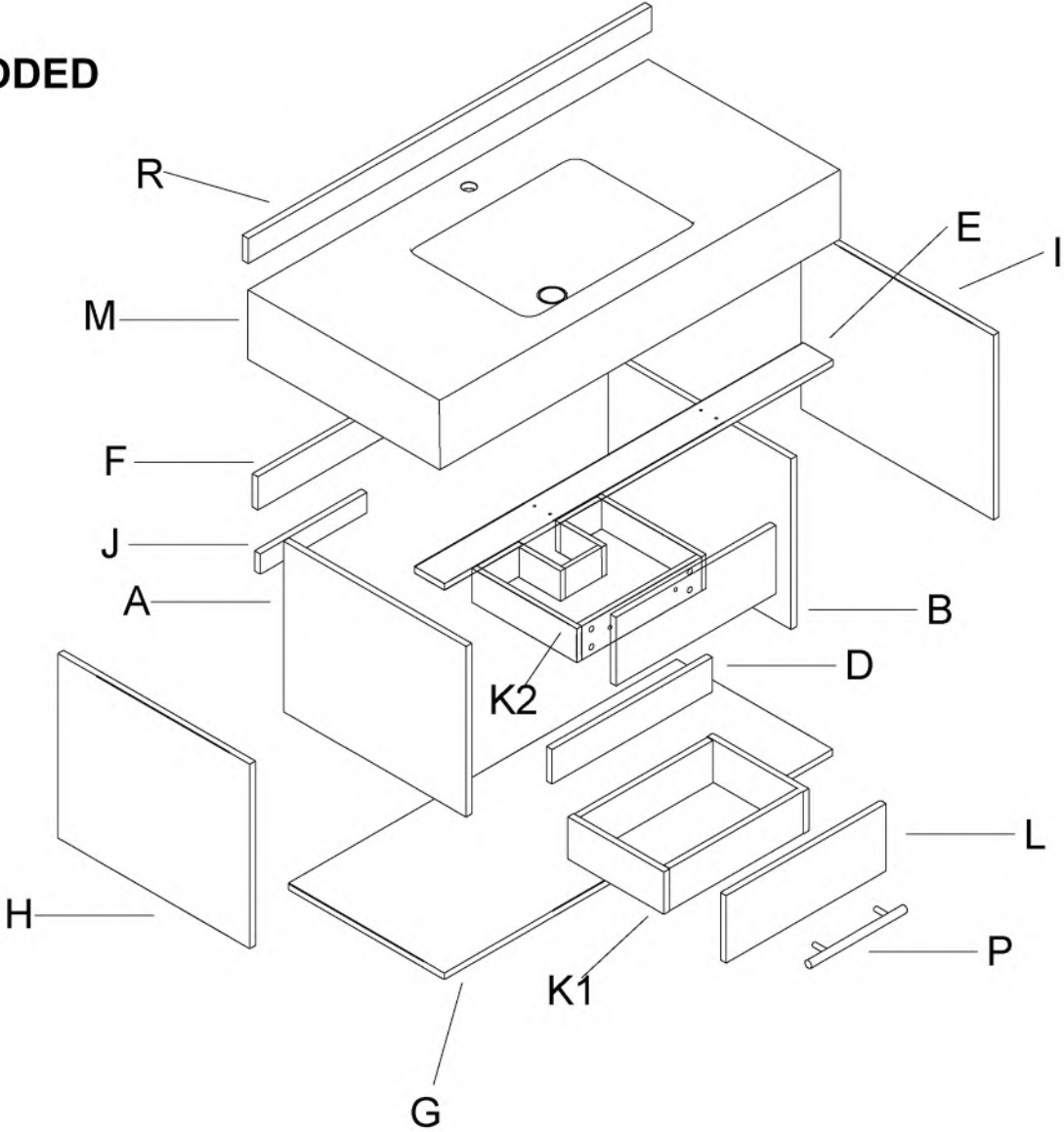

## COMPLETE



# Cam Lock Fastening System Installation

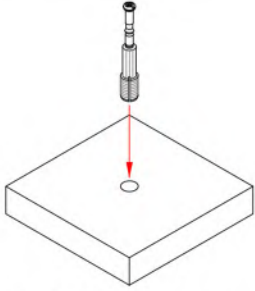

1. Install the screw rod

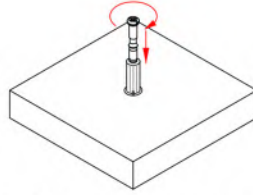

2. Tighten the screw rod clockwise

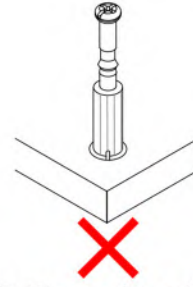

3. Pay attention to tightening the screw rod

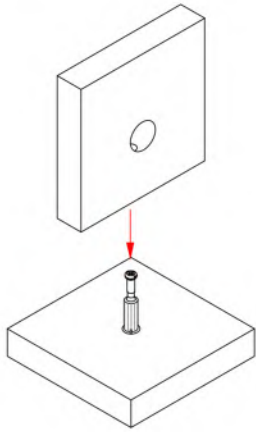
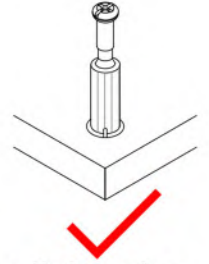

4. Installation plate

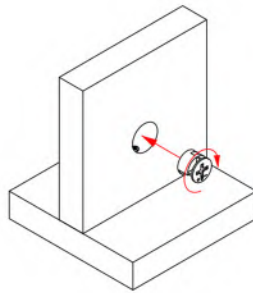

5. Align the arrow of the eccentric component with the screw rod

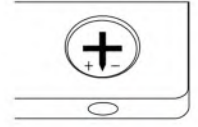
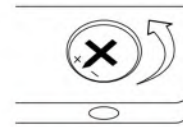

6. Pay attention to aligning the arrow of the eccentric part with the screw rod

# Installation Steps

## Step 1

AA  x4

BB  x4

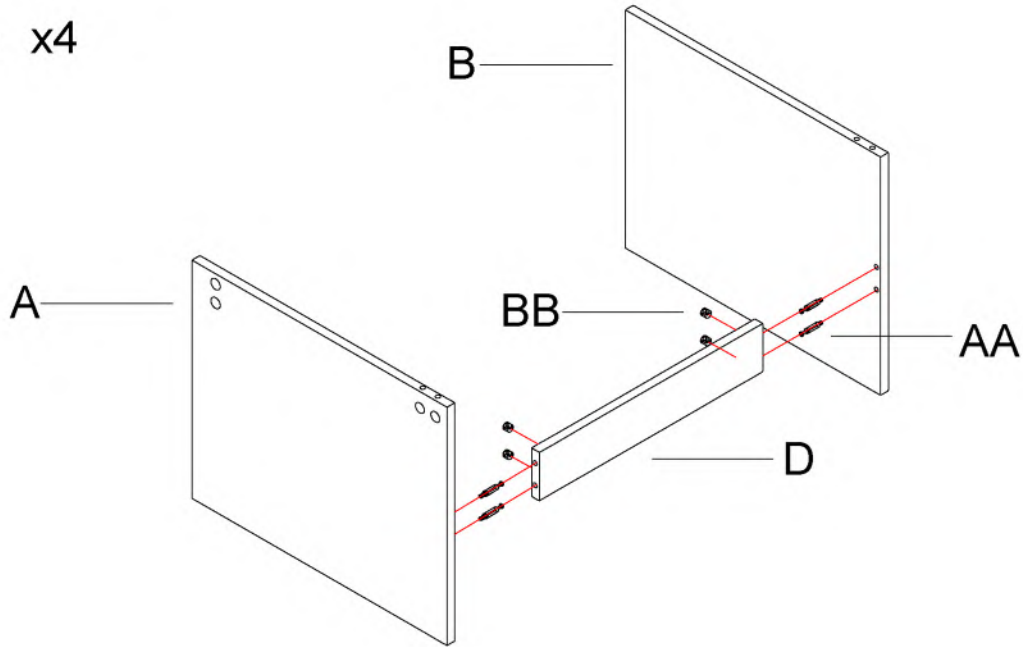

## Step 2

AA  x4

BB  x4

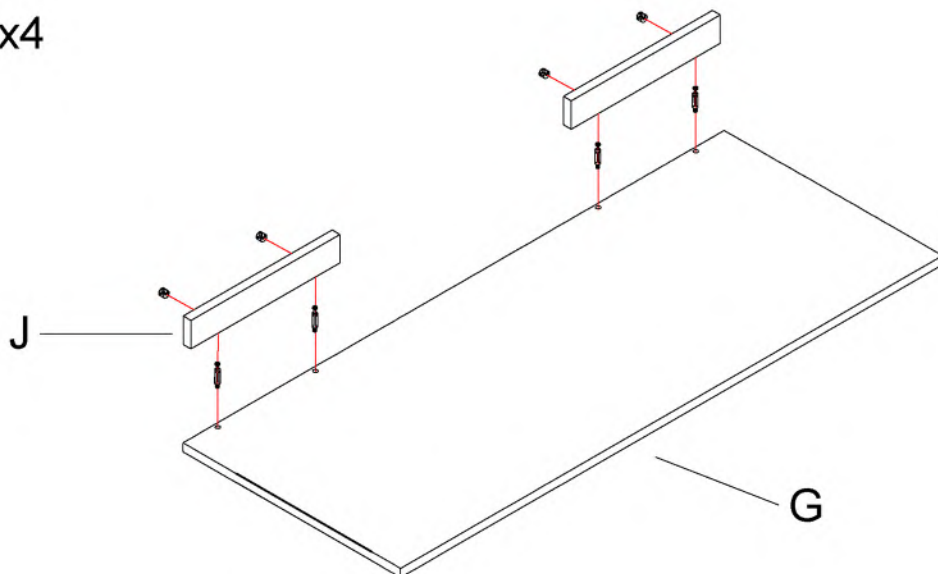



# Installation Steps

## Step 3

AA  x12

BB  x12

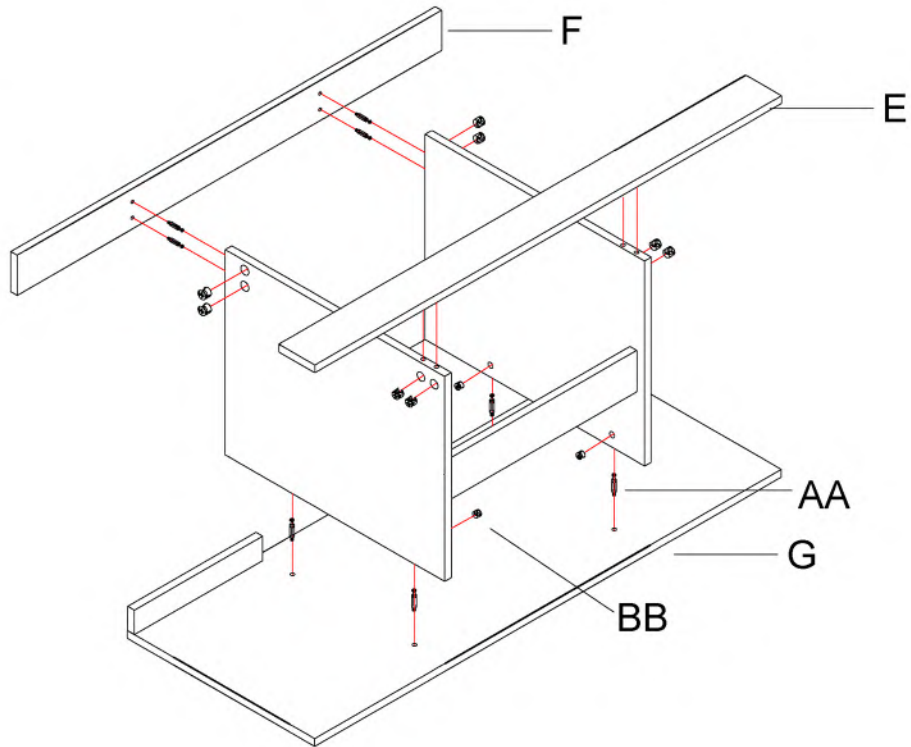

## Step 4

AA  x12

BB  x12

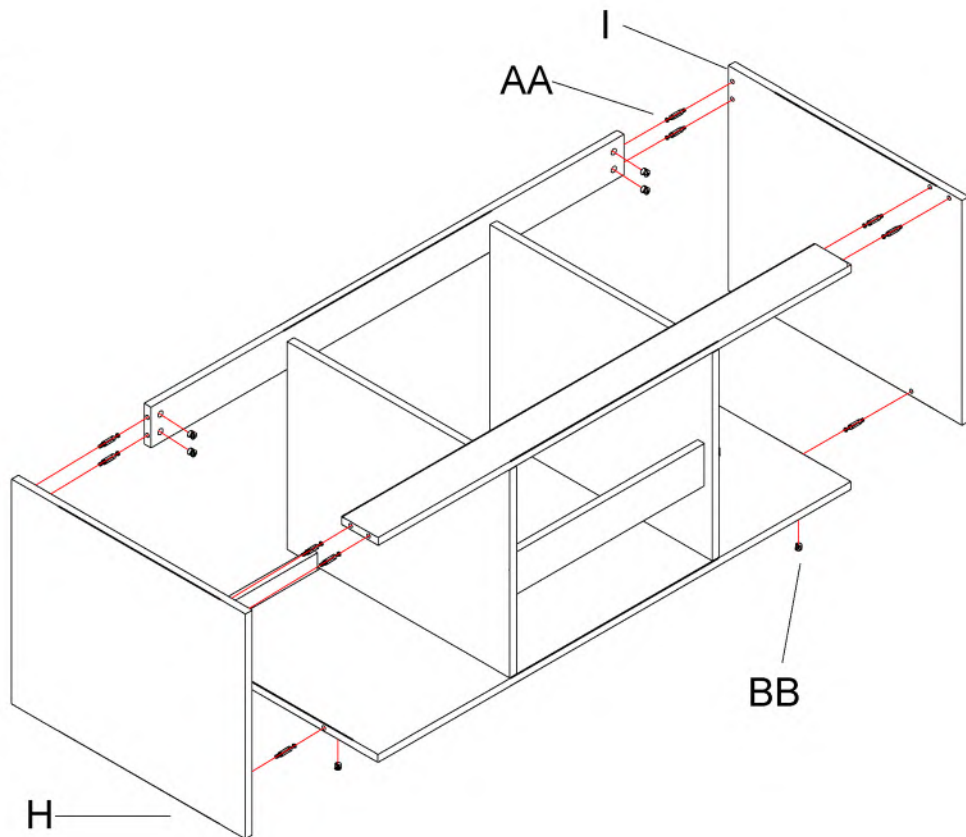

# Installation Steps

## Step 5

LL  x4

MM  x12

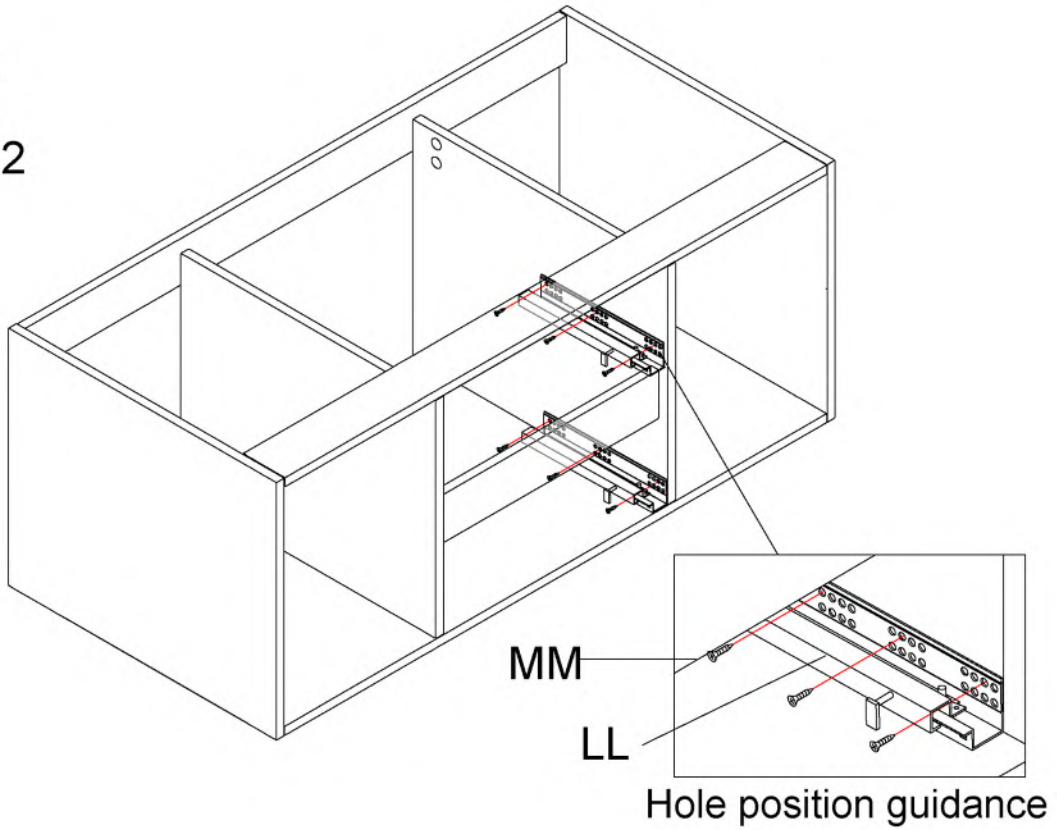

## Step 6

OO  x4

P  x2

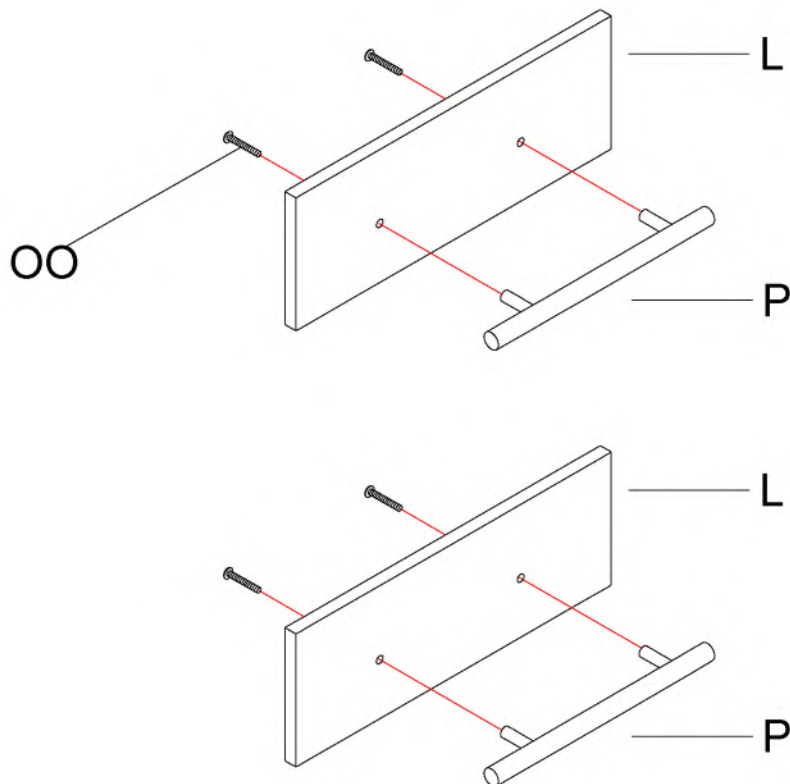

# Installation Steps

## Step 7

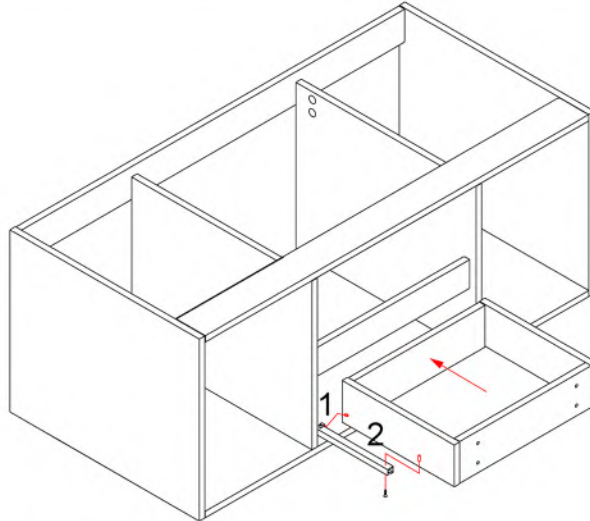

<p>front view</p>	<p>Buckle</p> <p>1</p>	<p>2</p>	
1. Check that the nut is screwed to the bottom.	2. Tilt the drawer down, and slide the drawer inside along the rails.	3. Put the drawer down naturally.	4. Push to lock Pull to unlock

## Step 8

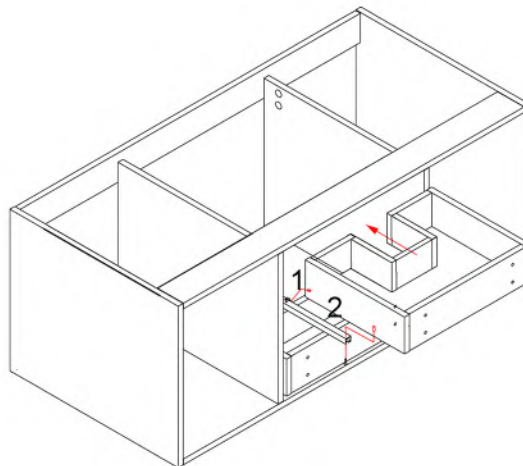

<p>front view</p>	<p>Buckle</p> <p>1</p>	<p>2</p>	
1. Check that the nut is screwed to the bottom.	2. Tilt the drawer down, and slide the drawer inside along the rails.	3. Put the drawer down naturally.	4. Push to lock Pull to unlock

# Installation Steps

## Step 9

CC  x2

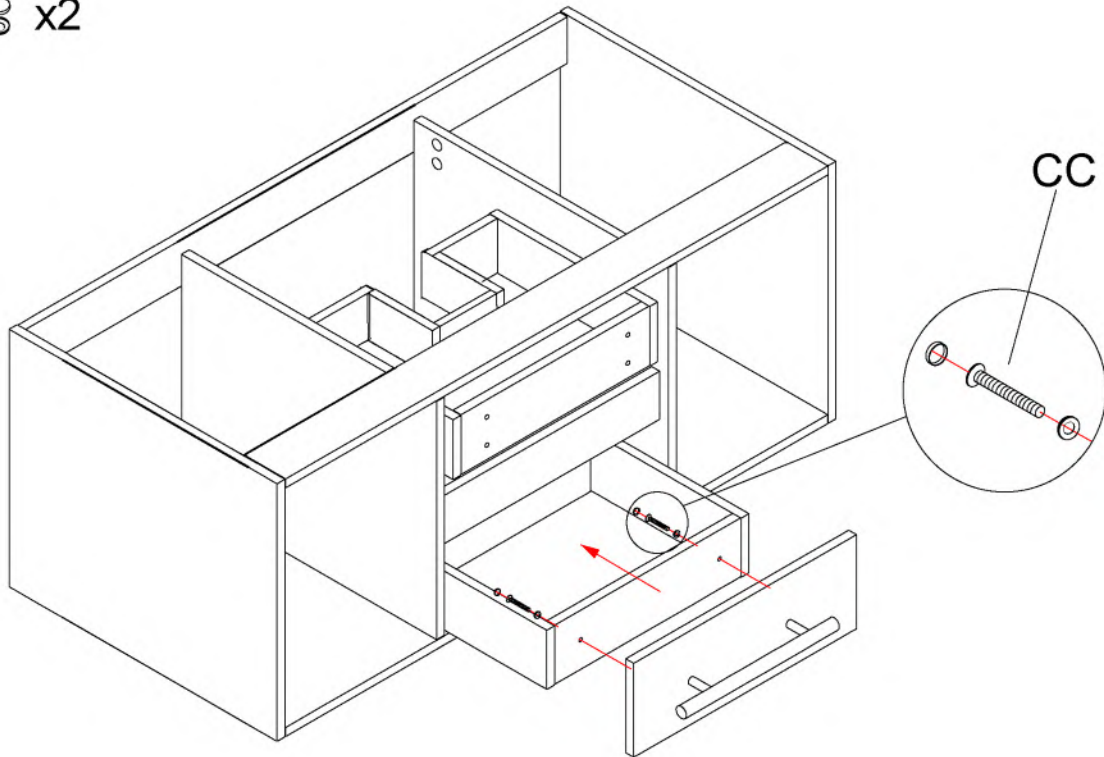

## Step 10

CC  x2

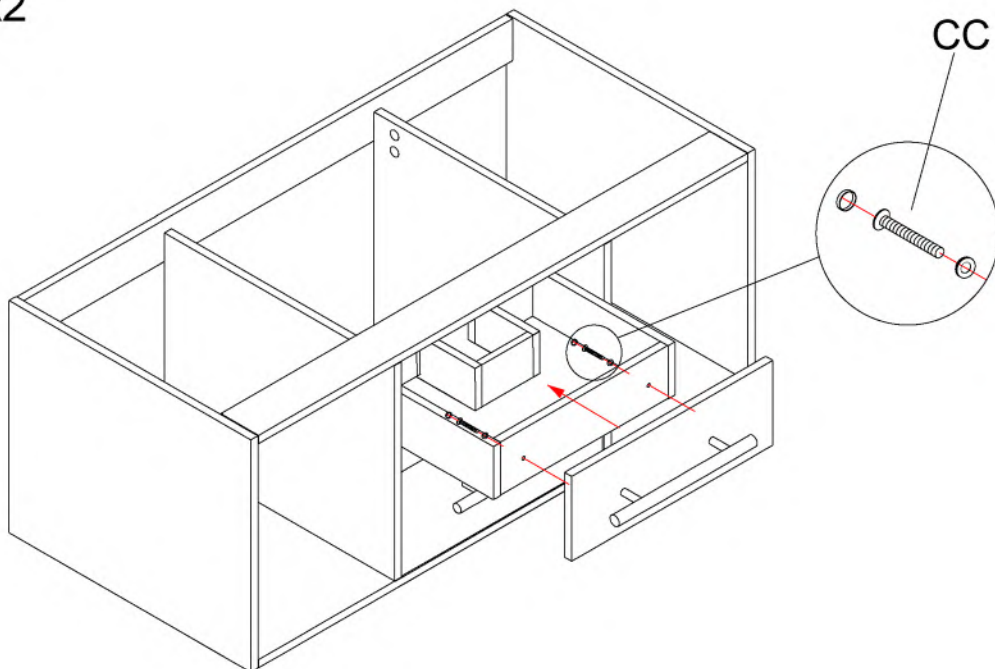



# Installation Steps

## Step 11

DD  x36

EE  x4

FF  x6

HH  x4

II  x2

JJ  x2

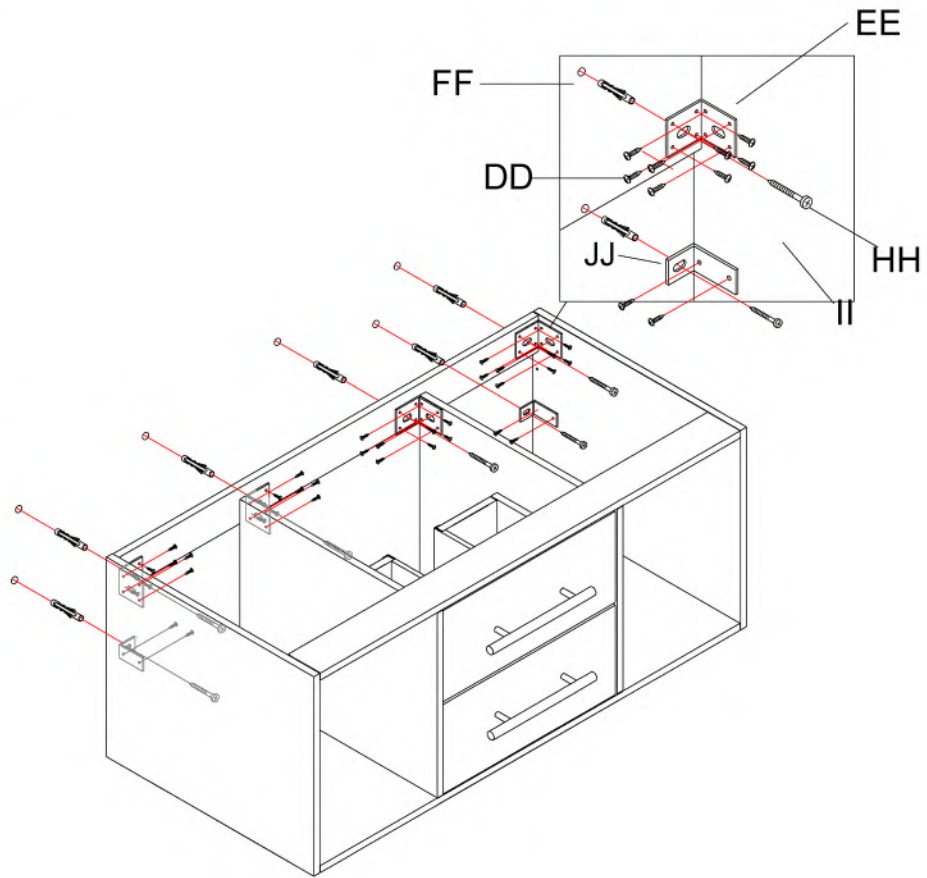

## Step 12

KK  x4

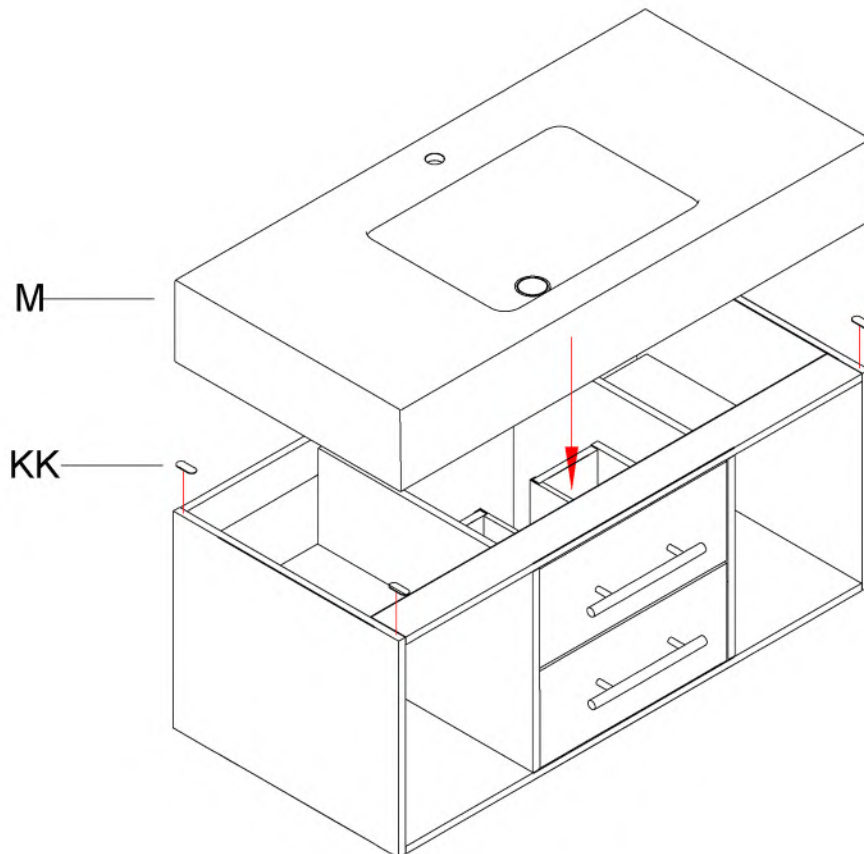

## Installation Steps

### Step 13

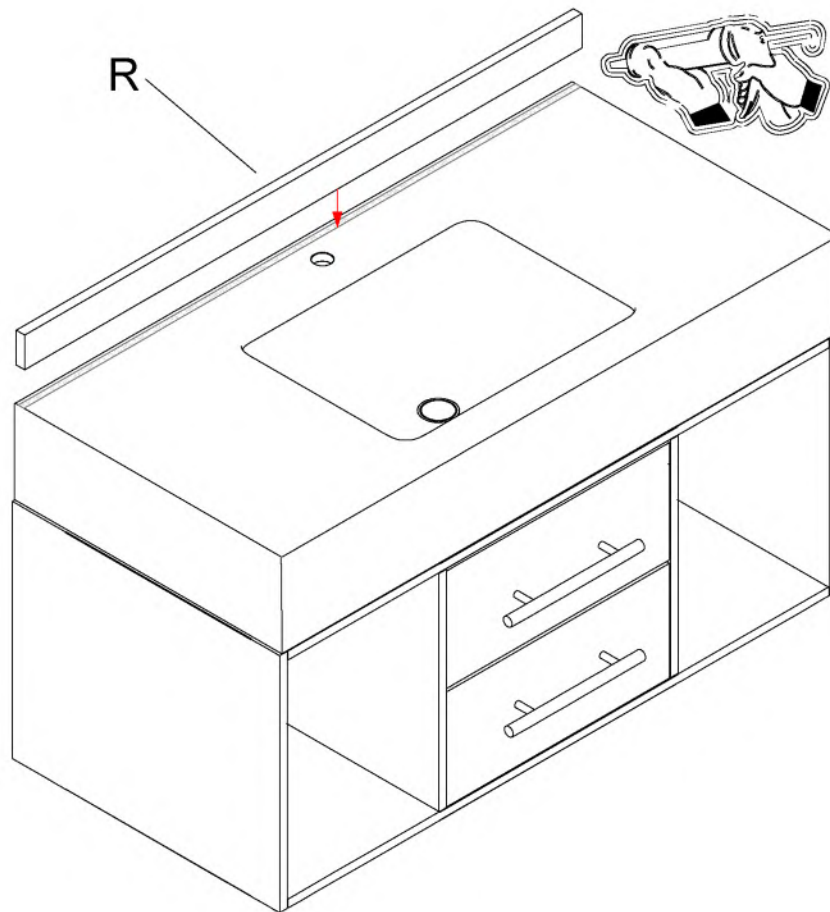

## Use and Maintenance

1. Keep the furniture vacant for half a month before use, and maintain good indoor ventilation to eliminate the residual odor in furniture surface coating.
2. Place the objects smoothly, Heavier objects should be placed at the bottom (layer) of the furniture to avoid the furniture from tipping over. Heavy objects should not be placed on the top of the wardrobe, so as not to cause the top plate to deform and sag and affect the opening of the cabinet door, high-temperature or frozen objects should be padded with high-temperature-resistant mats and placed on the furniture. Heavier or harder objects should be placed on the furniture table with a soft decorative tablecloth or a felt for protection.
3. Do not push hard objects directly on the furniture to avoid scratching the surface of the furniture.
4. Do not expose the furniture to sunlight for a long time or place the furniture close to the heating equipment, which can cause localized discoloration and fading.
5. Place the furniture stably to avoid breaking the furniture feet or loosening the connection parts due to inclination.
6. Do not let items that are flammable and oxidizing touch the surface of the furniture, which may cause chemical reactions and damage to the furniture finishing.
7. Teach children not to play close to the glass sharp angles of furniture avoid accidental physical injury and damage to the furniture.
8. Open the doors and drawers of the furniture with appropriate force, and it is strictly forbidden to open and close them violently, which will cause loose connections.
9. Screws may become loose during long-term use. If necessary, retighten them to ensure stability and security.

## Trouble Shooting

Product Category	Fault	Handing Method	Cause Analysis
Wood furniture	Door opening is not flexible	The furniture is not leveled	Use items to level the furniture
		The door hinges should be adjusted properly.	Adjust door hinges and apply lubricating oil
	Inflexible opening of drawer	Overload or deformation	Reduce weight,adjust guide rails, lubricate
	Loose component connection	Loose hinges or screws	The poke part should be coated with an appropriate amount of 502 glue,then re-install or tighten the screws.
	Minor scratches	friction with hard or sharp objects	Use a brush to apply similar pigment ink along wood grain to the scratches,then wipe off the excess.
Corrosive stains	Accidentally stained with chemical solvents such as nail polish,nail polish remover,ect.	Wipe them with a dry cotton cloth immediately	

### Possible issues during assembly.

·The two boards can't be aligned at the same level.

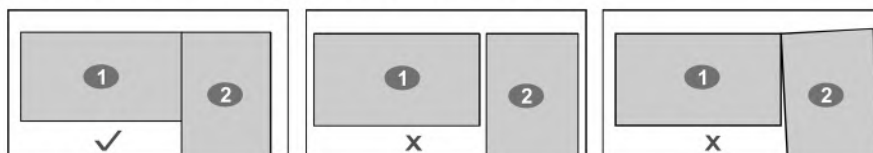

·Holes on the boards and poles are not aligned, so screws can't be installed.

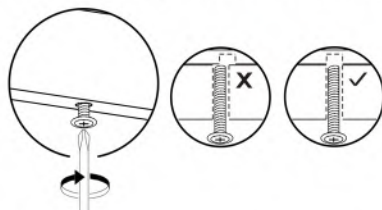

### Recommended solution:

·Please slightly loosen all screws and adjust the boards. Because the diameter of the holes on the pipes is 23 mm larger than that of bolts, the position of the boards can be adjusted.



·If it still doesn't work after adjustment, please contact us for more solutions.