

TABLE OF CONTENTS

Table of Contents

| | |
|-----------------------------------|----|
| Introduction..... | 01 |
| Precautions for Installation..... | 05 |
| Packing List..... | 07 |

Installation

| | |
|--------------------------------------|----|
| Preparation Before Installation..... | 09 |
| Size Chart..... | 10 |
| Installation Instruction..... | 12 |

Operation

| | |
|------------------------------|----|
| Precautions for Use..... | 14 |
| Accessories Instruction..... | 14 |

Care and Maintenance

| | |
|--|----|
| Precautions for Care and Maintenanc..... | 18 |
| Care and Maintenance Procedures..... | 19 |
| Troubleshooting Guide..... | 20 |

Introduction

In order to use our products safely and effectively, please read this instruction carefully.

Improper installation, operation and maintenance will cause the damage to the products and charge you extra repairing fee.

Thank you for choosing our massage bathtub series :

- This bathtub is for indoor use only, not for outdoor use.
- If you need any help, please contact local distributor or our company directly.
- Our company reserve the right to change all the models listed in this instruction without prior notice.
- This instruction applies to the listed products as below.
- Because of the difference of the market requirement and individual custom product, please refer to the corresponding content in this instruction according to the product and its functions you choose. In this way, you can install and operate the product correctly.

Notice

The meaning of the warning sign is as below:

This sign indicates that errant handling after disregarding this sign could result in personal injury or property loss.

- In order to install, use and maintain this product correctly and safely, please read and understand this instruction carefully.
- This manual is an important source of product information to help to use the product safely and correctly. Please keep it safe to avoid soiling or loss.

Standard Configuration of Massage Bathtub

Check whether the product number on the packing carton matches the product number of the massage bathtub and whether the massage bathtub configuration matches the configuration instructions in the manual. If they do not match, please do not use them, and contact the supplier in time.

| Standard Configuration of Massage Bathtub | | | |
|---|--|--------------|--|
| PARTS | MATERIALS/FUNCTION | QUANTITY | NOTE |
| Bathtub, decorative panel | Imported acrylic material composite glass fiber reinforced plastic insulation layer, stainless steel bracket | 1 set | The tank and skirt are factory installed. |
| Hydro massage pumps | Special hydraulic massage pump | 1 set | Installed on the bathtub stand, has passed the test. |
| Massage nozzle | Nozzle direction can be adjusted | 4-10pcs | Installed in the bathtub, already passed the test. |
| Hot and cold water inlet valve, changeover valve, waterfall faucet hose | All copper structure, ceramic spool hand wheel, and decorative cover chrome plating | 1 piece each | Installed on the side of the bathtub, passed the test, only need to connect the hot and cold water inlet pipe. |
| Pneumatic, regulating switch | ABS chrome plating | 1 each | Tested, (with computer controller without pneumatic switch). |
| Shower | | 1pc | Connected before installation. |
| Bathtub drainer | Specially designed water removal, with stainless steel brake cable, with a drainage hose | 1pc | Installed in the bottom of the bathtub, tested. |

Preparation Before Installation

Preparation Before Installation

- Make sure the place you install the bathtub is strong enough to bear the total weight of the bathtub, maximum water volume, and the user.
- Waterproofing process must be made in the bathtub installation area otherwise downstairs may get damaged if water leaks.
- The installation area must be equipped with water supply power supply and drainage.
- This product uses universal home power.

The electrical connections must comply with local authority regulations and must be done by an authorized electrician.

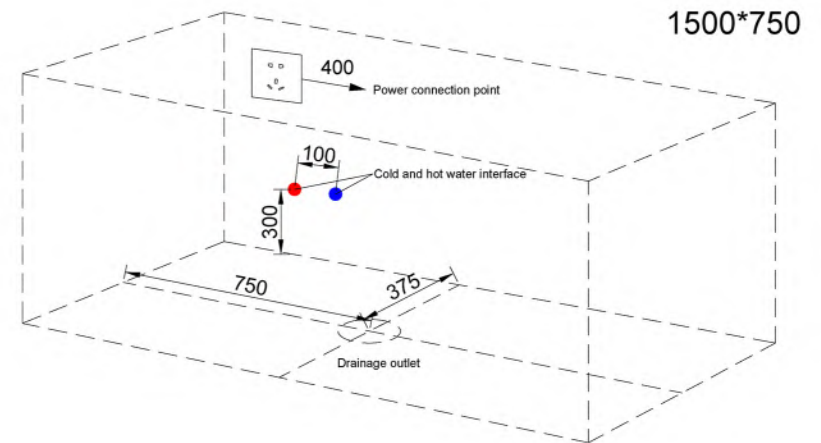

Notice

- * External circuitry needs to equip with a sensitive and fast type leakage protection switch. (Induced current rating below 15MA, trip time should be less than 0.1 seconds, and rated current is above 30A.)
- * The product should be installed on the grounding and electric leakage switch by a qualified licensed electrician.

Check sketches and room dimensions to provide enough space for bathroom fixtures.

When removing the bathtub from the protective carton.

DO NOT LIFT THE BATHTUB BY PIPE WORK.

- Please reserve the drainage hole $\geq \phi 50\text{mm} (\geq 1.97")$ and make sure the drainage pipes accord with the water valve.
- User shall reserve the connectors of 1/2 "external thread cold/hot water hoses, which outstand the wall 30mm. It is suggested to install a valve in each pipe, the location of installation should be designed by the user which is convenient for maintaining.
- As each bathroom or power and drain of each bathtub is slightly different please place the bathtub according to the actual situation the following illustration as a reference layout:

Notice : The safe distance between power supply and water supply should be not less than 30cm.

INSTALLATION REQUIREMENTS

A. Tools Required:

- Adjustable pipe
- wrench
- Ruler
- Level
- Safety shoes
- Safety glasses
- Screwdriver
- Pliers
- Utility knife

B. Materials Required:

- Plumbers putty
- Wall coverings, as necessary
- Silicone sealant
- Medium Bodied Pool & Spa Cements
- Construction adhesive (optional)
- Protective cover
- Tubs
- Nails

Check sketches and room dimensions to provide sufficient space for bathroom fixtures.



CAUTION

Ensure a waterproof sealing on the bathtub drain connections.

- Install the faucet valving and shower head tee. When drilling the bathtub for the faucet, ensure sufficient clearance. Open the hot and cold water valves and check the supply connections for leaks.
- Run water into the bath and check the drain connections for leaks.
- Fill the bathtub up to the overflow level and check overflow unit for leaks.

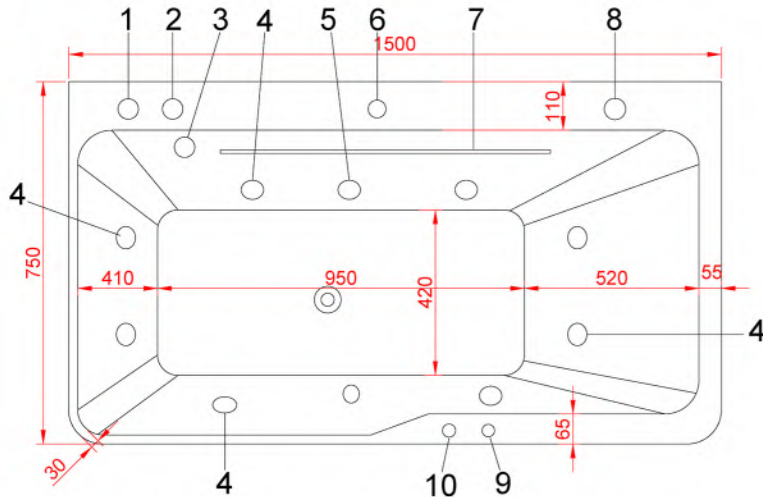

1. Hot-Cold Mixing Valve
2. Change-Over Valve
3. Drainage Valve
4. Nozzle jet
5. Light

6. Handle Shower
7. Waterfall
8. Waterfall Switch
9. Air Pressure Switch
10. Adjuster

Precautions for Installation

- Please check whether all parts are complete. If you have any question, please give feedback to our company in time.
- After opening the box please immediately dispose of unneeded packaging. Or it may cause personal injury by the wooden frames, nails, cardboard, or sealing straps which are placed carelessly.
- In addition, please do not let the children play with the packing material. Or it will cause personal injury.
- Parts containing electrically charged components (except those providing a safe extra-low voltage of no more than 12 V) must be kept out of reach of personnel during bathing.
- Earthed appliances must be permanently connected to fixed wiring.
- Parts incorporating electrical components except remote control devices must be located or fixed to prevent them from falling into the bathtub.
- Please do not use other power except specified power. Or it may cause fire or electric shock.
- Earth leakage protection switch should be installed outside the bathroom, otherwise it may cause fire or electric shock. Each Power cord Requires a Dedicated 120V 30AMP GFCI Breaker. The unit must be connected only to a supply circuit that is protected by a Ground-Fault Circuit Interrupter (GFCI). Such a GFCI should be provided by the installer and should be tested on a routine basis.
- Do not use the broken power supply, power plug, or loose socket. Or it may cause fire or electric shock.
- Do not modify the power supply cord, or use it with an extension cord, or combine it with other equipment using multiple plugs. Or it may cause fire, overheating or electric shock.
- Please make sure the power plug is waterproof with silicone protection. Or it may cause fire or electric shock by water infiltration.
 - * Before the installation finish, please use cardboard to protect the bathtub or it may lead the damage to the bathtub.
 - * Do not place a fire on the bathtub, such as a lighted cigarette or it may lead the damage to the bathtub.
- Do not stand on the tub while it is working. It may result in slipping or damage to the product.
- Install securely following the Installation Manual. Improper installation can lead to water leaks that damage or ruin household property.
- After finishing the installation, the product should go into trial operation fully to check whether the installation is proper or not.

Installation Instruction

Inspection Before Installation

Although all our massage bathtub is water tested before they leave our factory, there may be some loose hose connections due to the transport which may cause water leaking. We need to water-test the product before installation. The steps are as follows:

- Place the bathtub on a flat surface in an area where it can drain after testing. And adjust the leveling feet to make the bathtub level.
- Check if there is any loose of all connected systems.
- Close the door fill the tub with water to the overflow and allow standing for 10 minutes to inspect the tub for leaks.
- Insert the plug, fill the bathtub with water to approximately 50 mm (1.9"), run the pump for 10-15 minutes, could see if the water covers the double water level sensors on the tube side if they are not both covered by water, the air bubble function will not work.

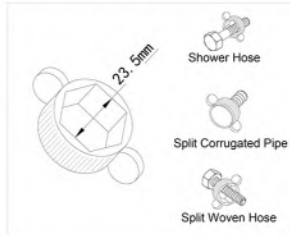

Check all the fittings for leaks and Start all the functions for a few minutes (which includes the functions of massage, air bubble, waterfall, and so on, inspect the tub completely, any defect must be reported to your dealer/distributor before installation to have it covered under warranty).

Check the pump and pipe union connections for leaks. Hand tightens union connections if required. It is recommended to use a medium-viscosity pvc plastic pipe adhesive to treat leaks.

1. Installation instruction for radio antenna position adjustment: blue wire can be extended and the end can be fixed in a better signal position.

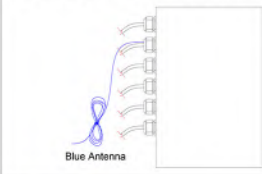

2. Pipe leakage in water distribution valve, shower, faucet position can be tightened by a small wrench.



Adjust The Leveling Feet

According to the different sizes of bathtubs, we design several leveling feet to adjust the bathtub. Please use a wrench or level ruler to level the bathtub.

Note: If the bathtub is not level, it may lead:

- noise increased.
- remaining water in the hoses or the drainage.
- bathtub shaking.

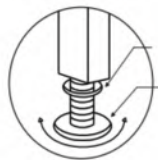

- Adjust the screw nut to the level position.
- Adjust the height of the leveling feet.

Installation Instruction

How to connect the water?

For ease of use, our bathtub is equipped with stainless steel cold and hot water hoses (connector $\varnothing 1/2"$). Please connect the cold and hot water hoses to the bathroom's cold and hot water hoses accordingly.

Before connecting the bathtub water inlet pipe, first, open the water pipe for some time, then put a filter screen to ensure that the debris will not enter the bathtub pipe. So that we can effectively extend the life of the fitting.

Insert the drain pipe into the drain hole on the floor and then cover it with water retaining cover to prevent sewage from spilling.

Notice Drain-pipe should be installed with a slope above 1:50. Do not hold the drain pipe and cold/hot water hoses when moving the bathtub, and do not crash it with hard objects.

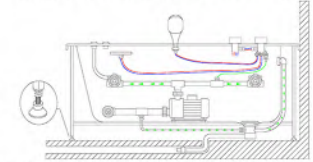

The bathtub has been equipped with a stainless steel cable brake drainer, which is flexible and durable in operation. Before you install the bathtub, you can reserve a drainage position according to the situation of the toilet. If the position does not match, you can connect it with a hose. Because the product has already tightened the sewer hose before leaving the factory, when adjusting the position of the sewer hose according to the actual situation, you only need to rotate the sewer hose clockwise twice, and feel that the sewer hose can be rotated to adjust the position, and there is no need for a whole sewer hose remove. After adjusting the position, tighten the drain hose to complete the adjustment. This can make your bathroom more refreshing and clean.
(This picture is for reference only)

How to connect the electricity?

Please install a proper dedicated plug with ground electrodes to the power line. And then insert the plug firmly.

Make sure the ground is connected: one side of the ground should be connected to the ground terminal of the motor and the stainless steel frame; the other side should be connected to the ground wires of the plug.

Notice The bathtub must be connected to the ground. Power outlet must be sealed well. Make sure the surface of each wire is intact.

Notice

Precautions for Use

! This instruction is for the massage bathtub series, not just for a certain model. Please refer to the model and configuration you choose when using the product.

Notice Use the unit only for its intended use as described in this manual. Do not use accessories that are not recommended by the manufacturer.

! Before the first use, you need to fill the bathtub with water, run the water pump and air pump for 10-15 minutes to drain the water in the bathtub, ensuring that the impurities harmful to human skin may remain in the bathtub pipeline during production process could be eliminated.

- Children shall not play with the appliance.
- Cleaning and maintenance shall not be made by children without supervision.
- Do not permit children to use this product unless an adult closely supervises them at all times. Supervision is also required when an elderly or disabled individual uses it.
- For the early months of pregnancy, pregnant or possibly pregnant women should limit whirlpool water temperature to 100°F(38°C) because excessive water temperatures have a high potential for causing fetal damage.
- People with a medical history of heart disease, low or high blood pressure, circulatory system problems, or diabetes should consult a physician before using a whirlpool.
- The use of drugs or alcoholic beverages before or during whirlpool use may lead to unconsciousness with the possibility of drowning.
- The water in a whirlpool should never exceed 104F(40C). Water temperatures between 100°F(38C) and 104°F(40C)are considered safe for a healthy adult. Use time should be limited to approximately 30 minutes, followed by a shower to cool down. Lower water temperatures are recommended for extended use(exceeding 10-15 minutes) and are recommended for younger children. If you feel nauseous, dizzy, or develop a headache, get out at once and cool down. Get medical attention if symptoms persist. Check with a physician before using the whirlpool again.
- People using medication should consult a physician before using a whirlpool since medication may induce drowsiness while other medications may affect heart rate, blood pressure, and circulation.
- Please use carefully according to the operating instruction to avoid the scald or catching a cold.
- Do not operate this unit without the suction cover over the suction fitting. This suction cover is a safety device that reduces the potential hazard of hair or body entrapment. Keep hair and body away from the suction cover when the pump is running.
- Never drop or insert any object in any opening within the whirlpool.
- Never operate electrically connected devices in or near the bath. Electric appliances shall not be placed within 5 feet/1.5 meters of this bathtub (such as hair dryers, lamps, telephones, radio, television, and so on).

B-10, HLW-30 Controller Main Functions

Figure 5 HLW-30 controller

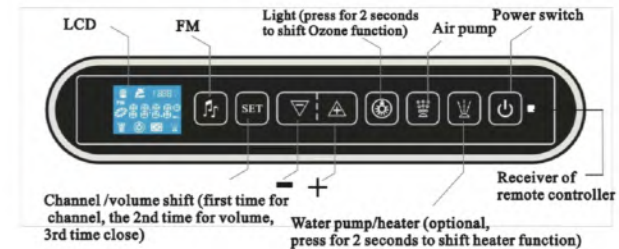

1. With the pump, underwater lights, radio, and other control functions.
2. When the water level is lower than the sensor, the pump will stop working.
3. Built-in FM stereo radio with beautiful sound quality, automatic station collection.
4. External CDs can be connected.

Operation Instruction

-Switch on: press the key to power on, and the whole system is in standby mode, and the screen shows "HELLO" characters.

-Underwater lighting: directly click the underwater light key, and you can switch the underwater light (rated power 20W), the screen has a symbol to show the working status.

-Ozone control function: directly click this key to control the ozone switch; the screen has a symbol to show the working status.

Note: HLW-30 should long press [underwater light key] for more than 2 seconds, you can switch it on and off.

- Water pump function: Click the pump key directly to switch the pump, the screen has a symbol to show the working status; in the state of water shortage, the pump can not be opened.

-Air pump function: Click the key directly to switch on and off the air pump, and the screen has a symbol to show the working status.

-Radio and CD: The radio/CD toggle button needs to be clicked repeatedly to cycle through the various audio functions.

- ① Click once to turn on the system's built-in FM stereo radio.
- ② Click it again to turn off the radio and output the music played by the external CD player.
- ③ Press again to turn off all audio output.

This system has a built-in FM stereo radio with a frequency display, digital tuning, and automatic station search and storage function. When the radio is turned on, tap the Tuner Decrease key down (between 88.0MHz-108.0MHz) to search channels manually, and press the Tuner Increase key up to search channels manually; at the same time, press and hold the Tuner Decrease key down (between 88.0MHz-108.0MHz) to search channels automatically, and press and hold the Tuner Increase key up to search channels automatically, through which you can select your favorite channels.

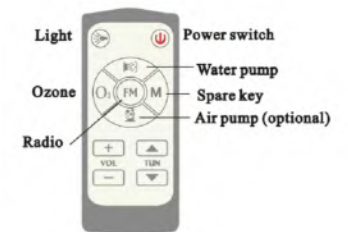

- ★ Press the volume adjustment key: you can adjust the volume level.
- ★ Water level detection: The system has high and low water level detection functions, the pump can not be turned on in the state of water shortage, and the screen displays the water shortage symbol.
- ★ Shutdown: Press the on/off key to turn off all functions and displays.

Caution

- ★ The user must install the load in strict accordance with the parameters provided by our company.
- ★ The ground wire of the electric control system must be connected to the power supply line with good grounding.
- ★ The user must use the qualified power supply wire above 2.5mm², and the socket used for the electric control system electricity must be a qualified product above 10A and reliably installed.
- ★ The wiring of the power supply box and control box should be strictly checked and confirmed to be correct before powering on and using.
- ★ Motor ground must be connected to a special ground, special ground diameter ≥ 2mm².
- ★ To ensure a good radio effect, the antenna should be adjusted to the right position.
- ★ The connecting wires of the electric box should be connected according to the bits and specifications of the connector, and the output lines should not short-circuit each other.

Parameters of Massage Bathtub:

★ Performance Index

Rated voltage: AC110V 50HZ

Withstanding voltage strength: 1250V/1min, no breakdown.

Waterproof level: 1Px5

Anti-electrical shock: Class 1

Parameters of Massage Bathtub

★ Performance Index

Rated voltage: AC110V 50HZ

Withstanding voltage strength: 1250V/1min, no breakdown.

Waterproof level: 1Px5

Anti-electrical shock: Class 1

Instructions for Electronic Control Panel Functions

Double Great Falls

- ① Induction computer controller (HLW30A3), FM radio and speaker, water level induction, ozone disinfection.
- ② Hydro surfing massage (2HP water pump, 4 large + 8 small hydro nozzles).
- ③ Water level sensing.
- ④ Massage strength adjustment switch.
- ⑤ Bubble bath (300W wind pump, 8 bubble nozzles with seven-color automatic color changing LED lights and bubble nozzle).

Note : When the water level is lower than the sensor, the pump will stop working.

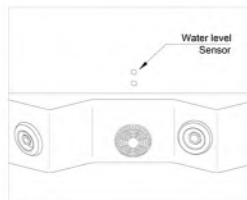

Operation Accessories Instruction

Cross Handle Three-Piece Set Faucet

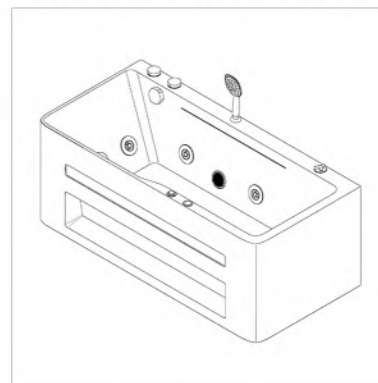

Drain Switch

Rotate the drain switch clockwise to close the drain, and rotate the drain switch anticlockwise to open the drain. When the water is over the maximum water level, the excess water will be drained by overflow.

Big water jets

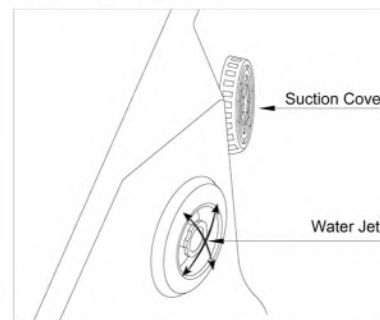

! Notice: Never operate the bathtub with the safety suction cover off.

Turning the head of water water jets up, down, left or right can adjust the angle of inflow.

Care and Maintenance



Notice

- Always implement countermeasures for preventing freezing. Must empty the bathtub and the water in the pipe during winter use. It is possible that the pipes could freeze, rupturing the pipes or equipment.
- Do not use water except standard tap water. The use of well water could cause corrosion, which could lead to leaks.
- The bathtub should be prevented from irradiating by ultraviolet light or bright light. Otherwise, it will accelerate aging and damage.
- Keep far away from cigarette butts, hair dryers, and other heat sources, the product will be damaged due to high-temperature deformation.
- When the bathtub is not in use, please keep it ventilated and dry, avoid contact with corrosive substances, no electricity, no water.

To avoid damage when the appliance is left empty for an extended period. Do not drop or strike the bathtub with hard objects. Otherwise, the tub may break or scratch or cause leaks that could damage or destroy household property.

When the product is working, do not cut any connection line, split the bus bar and the control board (the user cannot separate any part of the control board and the bus bar), otherwise it may cause accidents such as electric leakage and electric shock of the product.

The Ground Fault Circuit Interrupter (GFCI) should be tested periodically. It is suggested to test before each use.

Use water or mild detergent to clean the product:

Please do not use acid, alkali, organic solvent chemicals, acidic and alkaline cleaners. Otherwise, the surface of the product will be damaged. When stains cannot be removed with water or neutral detergent, wipe with a clean cloth dipped in a little alcohol to remove the stain.

Hardware parts maintenance:

scrub with cotton cloth. Light scratches and dulled areas may be restored to their original luster by using #1200 waterproof sandpaper dipped in water to coarse grinding. Then using #2000 waterproofsandpaper dipped in water to fine grinding, finally polishing with a soft cloth and polishing agent.

Regularly taking care of your bathtub will keep it clean and working at its best. Pump and pipe circulation systems should be flushed before first use and every month when the product is under normal use. Below are the recommended procedures for cleaning:

1. Do not run the jet massage system dry.
2. Fill the bathtub with hot water (about 40°C) 2-3 cm above the jets and add 2-3 teaspoons of low-foaming detergent such as dishwashing machine detergent.
3. Turn on all the functions and run for 10 minutes.
4. Drain the bathtub completely.
5. Fill the tub with cold water above the jets.
6. Turn on all the functions and run for 15 minutes.
7. Drain the bathtub completely.
8. Cleaning the "suction cover": Clean and remove any hair or lint from the suction cover.

Every month, unscrew the suction cover and clean away any hair lint or debris from the cover and housing, then remount the cover in place. Some suctions are not designed to be removed; only suctions that have screws on the cover visible from the inside of the tub can be removed.

Notice: Never operate the bathtub with the safety suction cover off.

Troubleshooting Guide

| SYMPTOMS | PROBLEMS | SOLUTIONS |
|---|---|---|
| Motor does not turn | Power supply | Check whether the power supply is normal and whether the power plug is inserted tightly. |
| | The pneumatic switch does not work, whether the leather bag is broken | Adjust the pneumatic switch, replace the leather bag. |
| | Pneumatic switch connection tube is not inserted tightly or bent | Insert tight or straighten the air tube. |
| | There are debris stuck in the motor impeller | Clear impeller debris or replace impeller. |
| | Air switch or capacitor in the motor is damaged | Repair or replace the motor. |
| Motor noise is too loud | The motor coil is short-circuited | Repair or replace the motor. |
| | The foot screw is not flat | Level the foot screws. |
| Air pump does not work | The connection between the pump and the motor bracket is loose | Tighten the nut. |
| | Power supply | Check whether the power supply is normal, and whether the power plug is tightly inserted. |
| | There are debris blocking the air outlet | Clear the debris in the pipe. |
| Can't turn on the electricity leakage switch | Air pump into the water burned | Replace the air pump. |
| | User power supply is connected wrongly | Reconnect the power cord. |
| | Capacitor or coil short circuit in the water pump | Replace capacitor or motor. |
| | The transformer in the water bottom class is short-circuited | Replace transformer. |
| Underwater light does not light up | Leakage protection plug has been bad | Replace the leakage protection switch. |
| | The bulb is broken | Replace light bulb. |
| | Wires are not connected properly | Reconnect. |
| The control panel has no display. Operation does not work | Led controller is damaged | Replace Led controller. |
| | Control panel signal line contact is not good | Reconnect panel signal line. |
| No water in the bathtub | Panel keys are not working | Replace the panel. |
| | No water in the water pipe | Open the water inlet connector to see if there is water. |
| | Water valve is blocked | Clean the water inlet valve. |
| No drainage | Water inlet hose bent | Smoothing water inlet hoses. |
| | Clogged water drain | Mobile bathtub cleaning. |
| Drainage is not clean | Clogged user water | Move the bathtub to clean it. |
| | Uneven bottom of the tank | Adjust the bracket, and balance the bathtub. |
| Massage bathtub leaking | Poor hot and cold water hose connector | Replace the rubber gasket and well-locking joint. |
| | Poor sealing of parts and cylinder | Replace the seal rubber ring. |
| | Poor bonding of water pipe joints | Re-gluing. |
| | The joint is not locked tight | Lock the connection nut. |
| | Water pipe rupture | Replace the water pipe. |
| Water Switch leaks | Damaged cartridge | Replace the cartridge. |