

2174 - 48" Centaurus Pyramid

# Constellation™

assembly instructions

SONNEMAN®  
A WAY OF LIGHT

# Constellation™ Product Information and Warnings

## Important

- **Always disconnect the power before installing or replacing Luminaires and before cleaning or other maintenance.**
- **Consult a qualified, licensed electrician to ensure correct branch circuit conductor.**  
*Consulter un électricien qualifié pour vous assurer que les conducteurs de la dérivation sont adéquats.*
- Please read all included assembly instructions and warnings carefully before installation. Contact Customer Service if you have any questions or concerns. Before installation, please confirm that the fixture is compatible with your supply voltage and dimming system, if present.
- LEDs are highly sensitive electronic devices, and must be treated with care. Do not open any factory sealed compartments, and avoid touching the LEDs with your hands or any object.
- Although all our fixtures are equipped with protective devices, LED electronic systems are vulnerable to power surges and supply variations. Do not install LED fixtures on the same circuit as any motors, appliances, or HVAC systems.
- Remote LED Driver installation must be done by a licensed electrician and in accordance with local building and electrical codes. Remote installations should be in an accessible location, as close to the fixture as possible. The appropriate wire gauge must be used to limit the voltage drop to avoid overloading the LED Driver.
- Any mounting hardware is provided for your convenience and should be used with discretion. Always use the appropriate hardware for the mounting surface.
- Constellation™ LED Drivers are 24VDC Constant Voltage output.
- Constellation™ must be installed in dry locations ONLY.

# Welcome to Constellation™

A Constellation configuration is built from LED hubs, connecting arms, end arms, and cable hangers. Illumination radiates through either the white optical acrylic lenses, or sparkles with refracted light through micro-faceted clear acrylic crystal lenses. Each hub is a complete LED light engine, using an array of LEDs with driver circuitry on each of the two faces of the hub. The connecting arms form a structural and electrical connection between the hubs, and are easily assembled by inserting the arm into the hub and are secured in place by a retaining set screw. The hubs can revolve around the connecting arms to alter the orientation of the illumination and that of the intersecting connecting arms. The configuration is supported by cable ceiling hangers that slide onto an arm and lock into place as needed, and is powered by a special power feed cord connected to the canopy.

## WHAT COMES IN THE BOX

### Power Feed and Power Supply

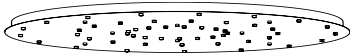
System #	Qty	Model	
2174	1	21XD04xx51 48" Canopy	

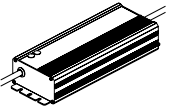
System #	Qty	Model	
2174	3	LTF DS200W24VBR3UD-4002	

### Power Feed Hardware

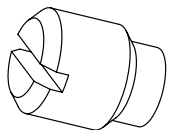
System #	Qty	
2174	51	

Slotted Set Screw

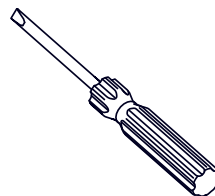

Screwdriver  
(Qty 1)

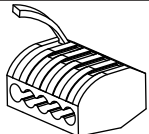
System #	Qty	
2174	36	

Electrical Connectors

## Hubs

System #	Qty
2174	204

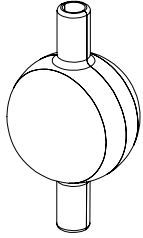

180° Hub

System #	Qty
2174	408+



M2 Set Screw

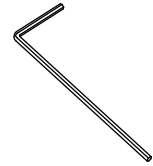

Small Hex Wrench  
(Qty 3+)

## Arms

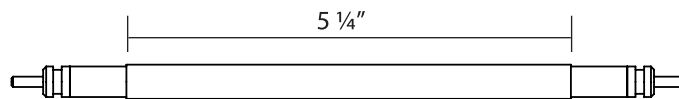

System #	Qty
2174	153

21XB01xx05  
Connecting Arm

System #	Model #	Length	Qty
2174	21XB02xx08	8 ½"	17
2174	21XB02xx06	6 ½"	17
2174	21XB02xx04	4 ½"	17

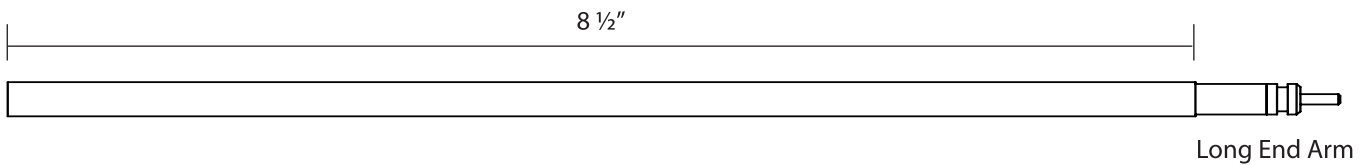

Long End Arm



Medium End Arm



Long End Arm

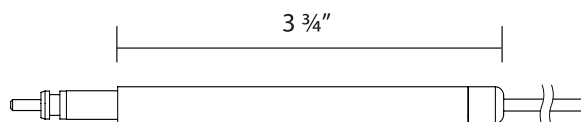

System #	Qty
2174	51

21XC03xx10  
Power Feed Cord

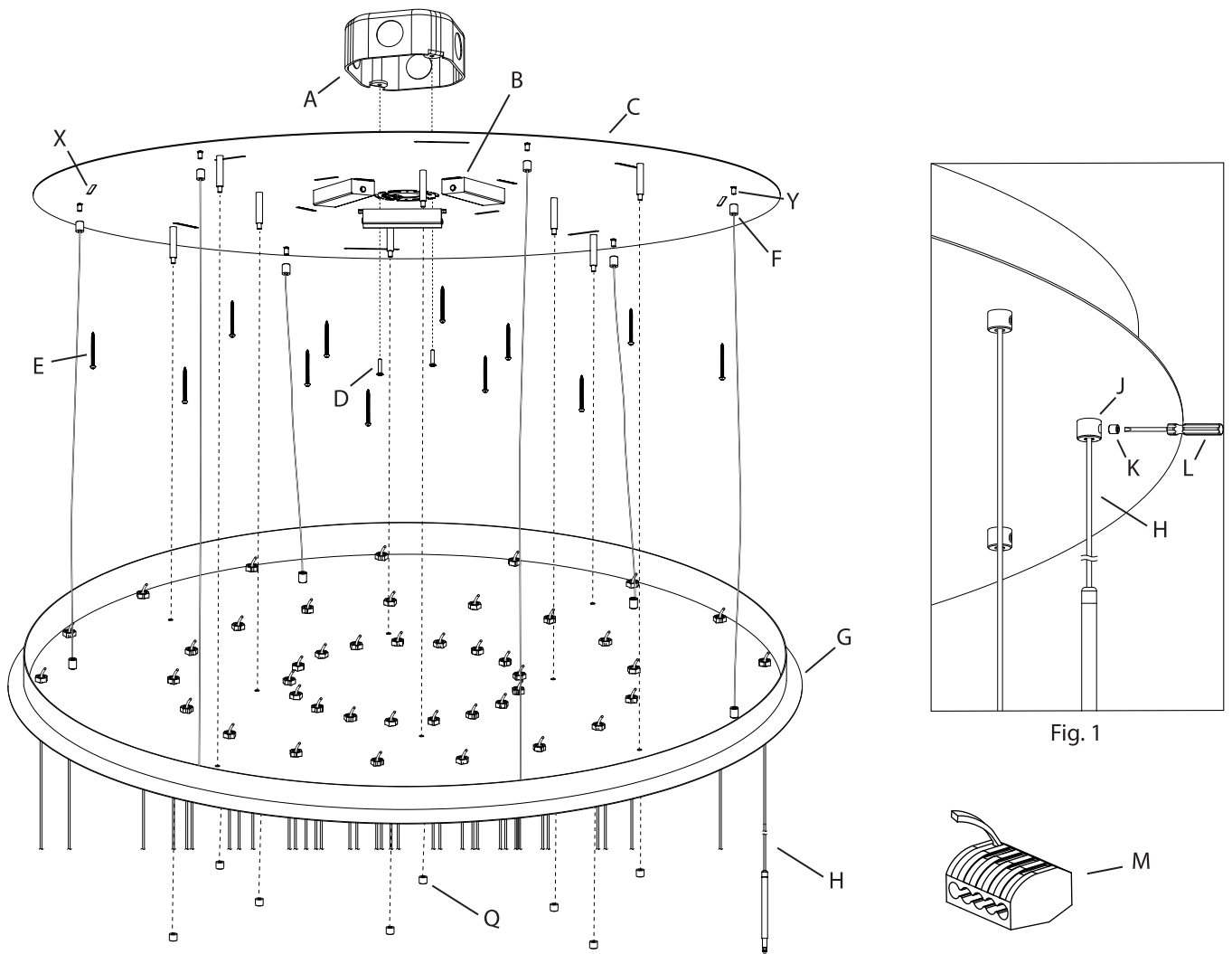

Fig. 1

**Canopy Installation:**

1. Shut off power to the outlet box (A).
2. Attach ceiling pan (C) to the outlet box, secure with outlet box screws (D). Use the slots (X) and wood screws (E) to secure the ceiling pan into the ceiling joists.
- CAUTION: Fixture must be supported independent of outlet box. Customer is responsible for ensuring appropriate ceiling construction to support the weight of the fixture.**
3. Make appropriate electrical connections using wire nuts. See Appendix A for instructions on stripping the coaxial cable.
  - a. Connect the LED driver's live wire (black) to the live supply wire.
  - b. Connect the LED driver's neutral wire (white) to the neutral supply wire.
  - c. Connect fixture's ground wire (green or uncoated) to the ground outlet box wire.
  - d. Carefully place connections in outlet box (A).
4. Screw the safety cable couplings (F) to the studs (Y) on the ceiling pan (C).
5. Feed the outer circle of power cords (H) through the bushings (J) on canopy (G) to approximate desired height plus 1 inch and tighten with set screws (K) using included screwdriver (L). This will be adjusted to exact height in a later step.
  - a. Repeat Step 5 with the middle circle of power cords, feeding the cord to 6 ¼" below the level of the outer circle.
  - b. Repeat Step 5 with the inner circle of power cords, feeding the cord to 13 ¼" below the level of the outer circle.
6. Connect the fixture wires to the lever nuts (M) by pulling up on the lever for an empty slot, inserting the wire, and pushing the lever back down to lock. The positive (inner conductor/red) fixture wire and negative (outer conductor/black) fixture wire on each cord must be connected to separate lever nuts. Wire all the power feed cords in accordance with Appendix B and C.
7. Reserve drivers (B), extra cords, and lever nuts (M) in canopy (G).
8. Attach canopy (G) to ceiling pan (C), secure with canopy nuts (Q).

### Arm and LED Hub Section Assembly:

1. Attach a Hub (S) to the end of each Power Feed Cord (T) by fully inserting the Cord into a Neck (U) on the Hub (Fig. 2a) and installing the M2 Set Screw (V) into the Neck (U) of the Hub, using the Small Hex Wrench (W) provided, and tightening until it comes in contact with the plastic cap on the Arm. **CAUTION: Do not over tighten the set screws.**
2. Complete each Drop as shown in Fig. 2b, 2c, and 2d and place into correct ring, using the same method as in the previous step.
  - a. Inner ring: Long Drop x17
  - b. Middle ring: Medium Drop x17
  - c. Outer ring: Short Drop x17
3. Restore power to the Outlet Box.

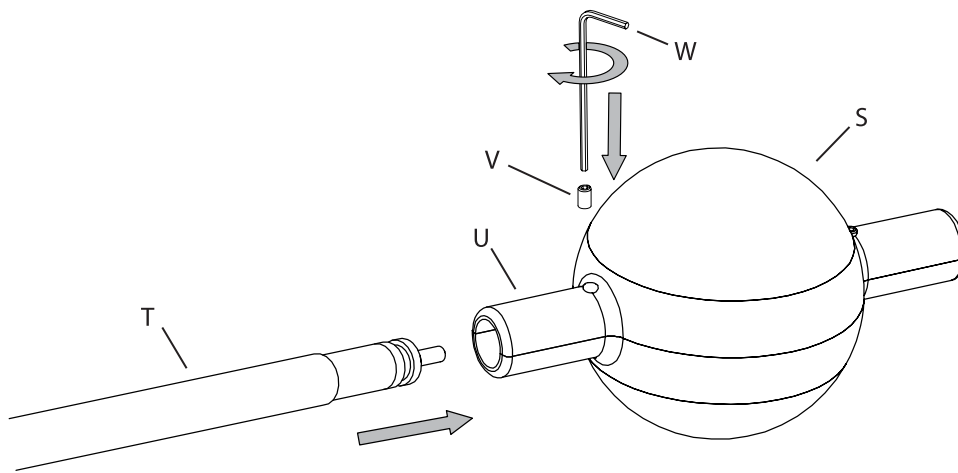

Fig. 2a

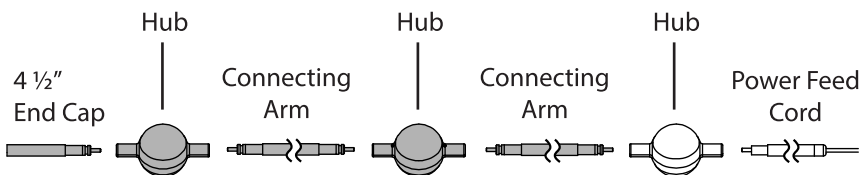

Fig. 2b - Short Drop

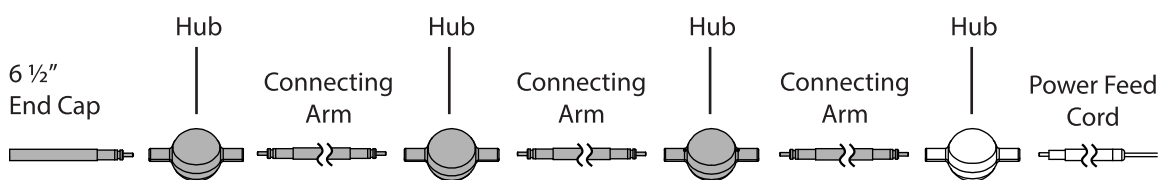

Fig. 2c - Medium Drop

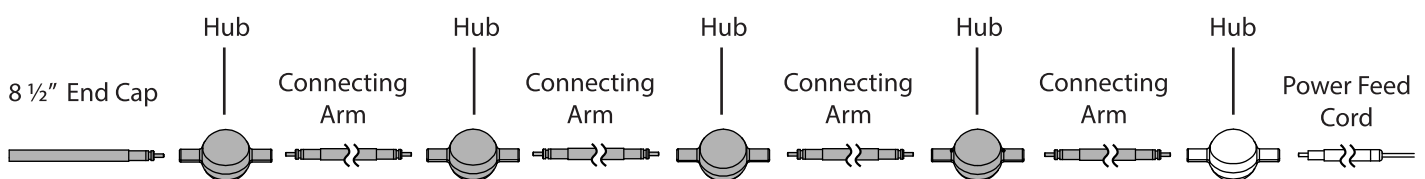
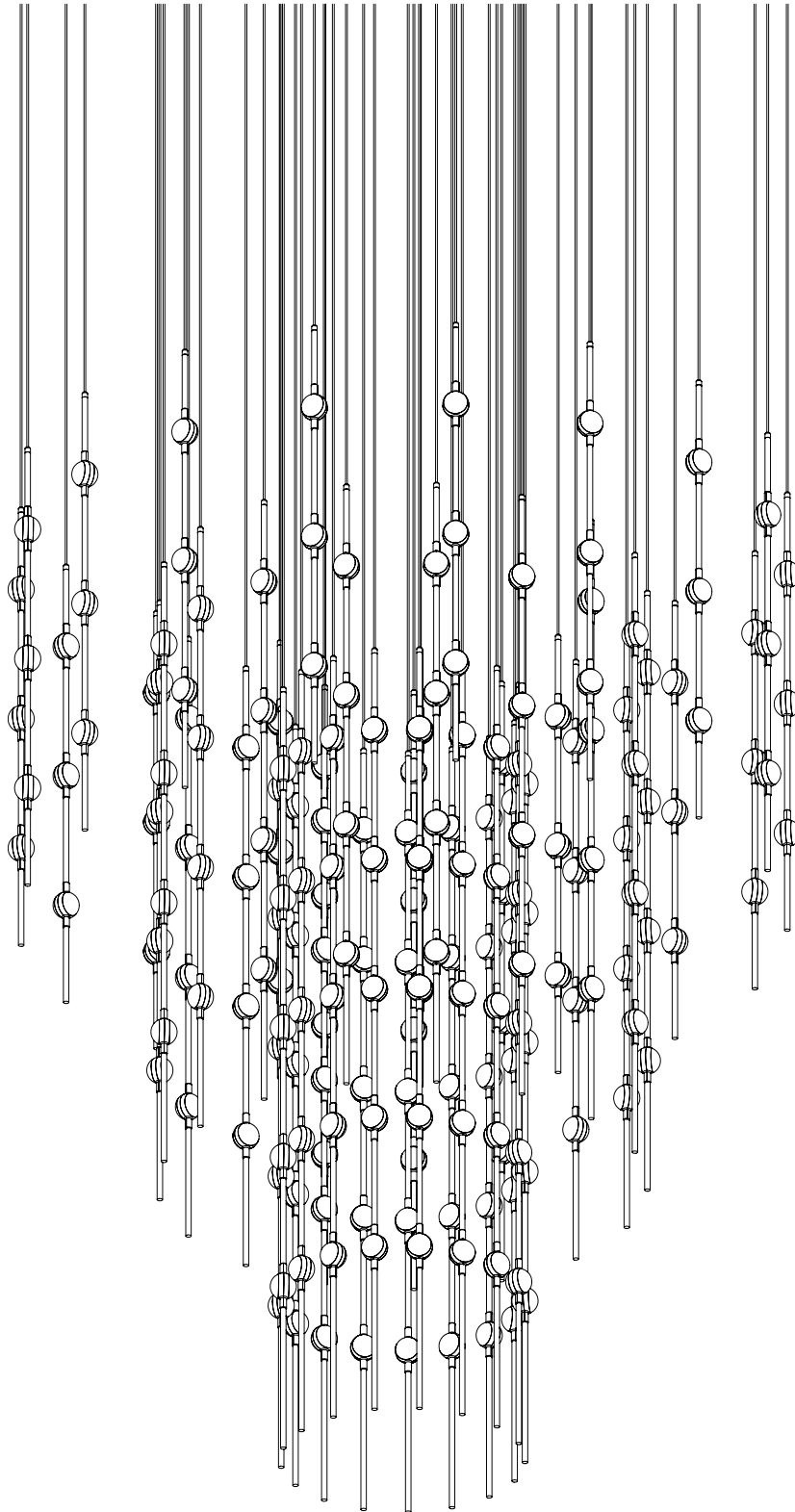

Fig. 2d - Long Drop

**COMPLETED ASSEMBLY**



# Coax Splicing Assembly Instructions

INSTRUCTIONS D'INSTALLATION

FAILURE TO FOLLOW THESE INSTRUCTIONS WILL VOID THE WARRANTY

Coaxial Power Cord:

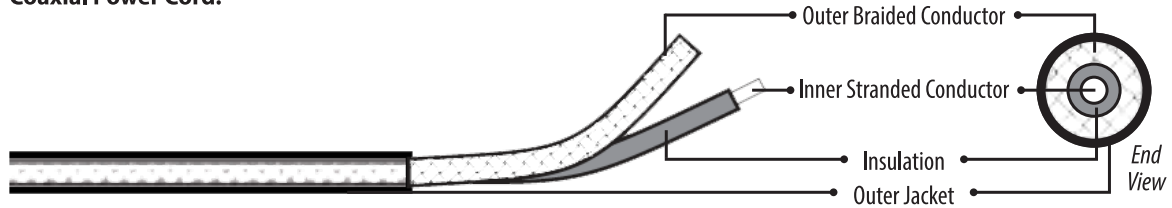

If field-cutting is required, please follow the below instructions:

1. Make a 1" slice along the length of the cord's outer jacket (Fig. 1). **CAUTION: Do not cut through the outer braided conductor.**
2. Carefully strip the outer jacket of the cord and keep the outer braided conductors intact (Fig. 1).
3. Slide the outer braided conductor back to create a bulge and reveal the inner stranded conductor (Fig. 2).
4. Bend the cord to create an opening through the bunched-up portion of outer braided conductor, then pull out the inner stranded conductor (Fig. 3)
5. Twist together the outer braided conductor to form the negative wire of the fixture, then strip 5/8" off the end of the inner stranded conductor to form the positive wire of the fixture (Fig. 4).
6. Re-splice all power cords.

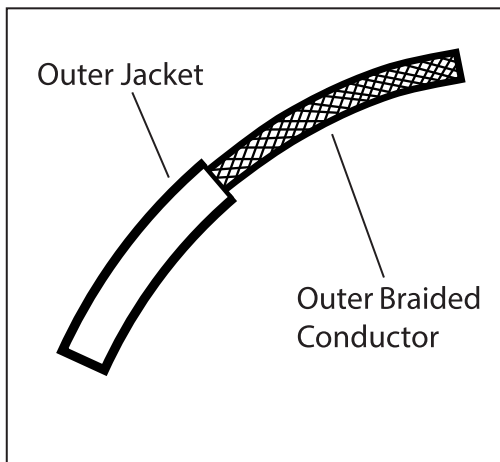

Fig. 1

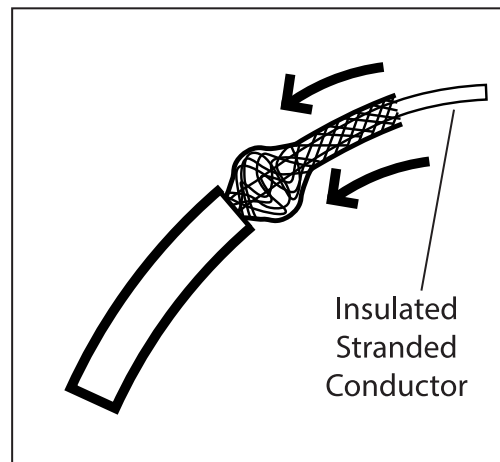

Fig. 2

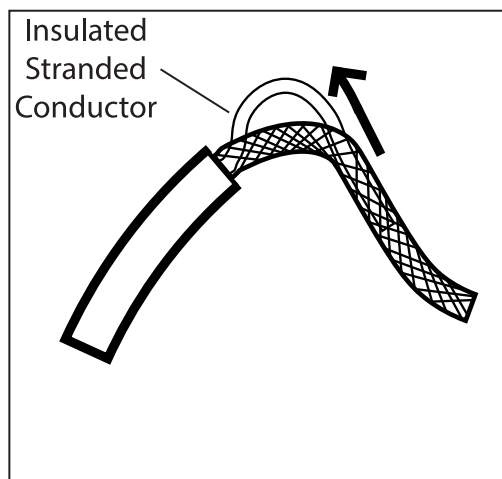

Fig. 3

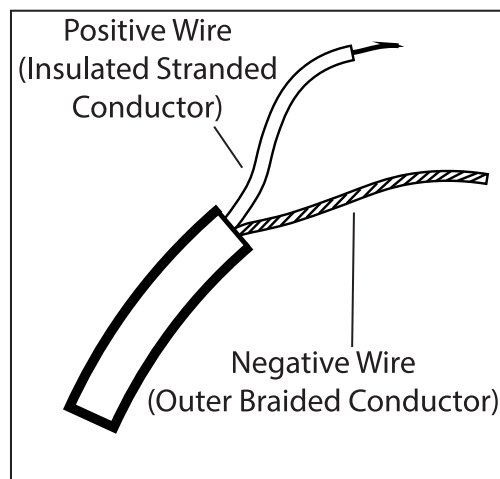
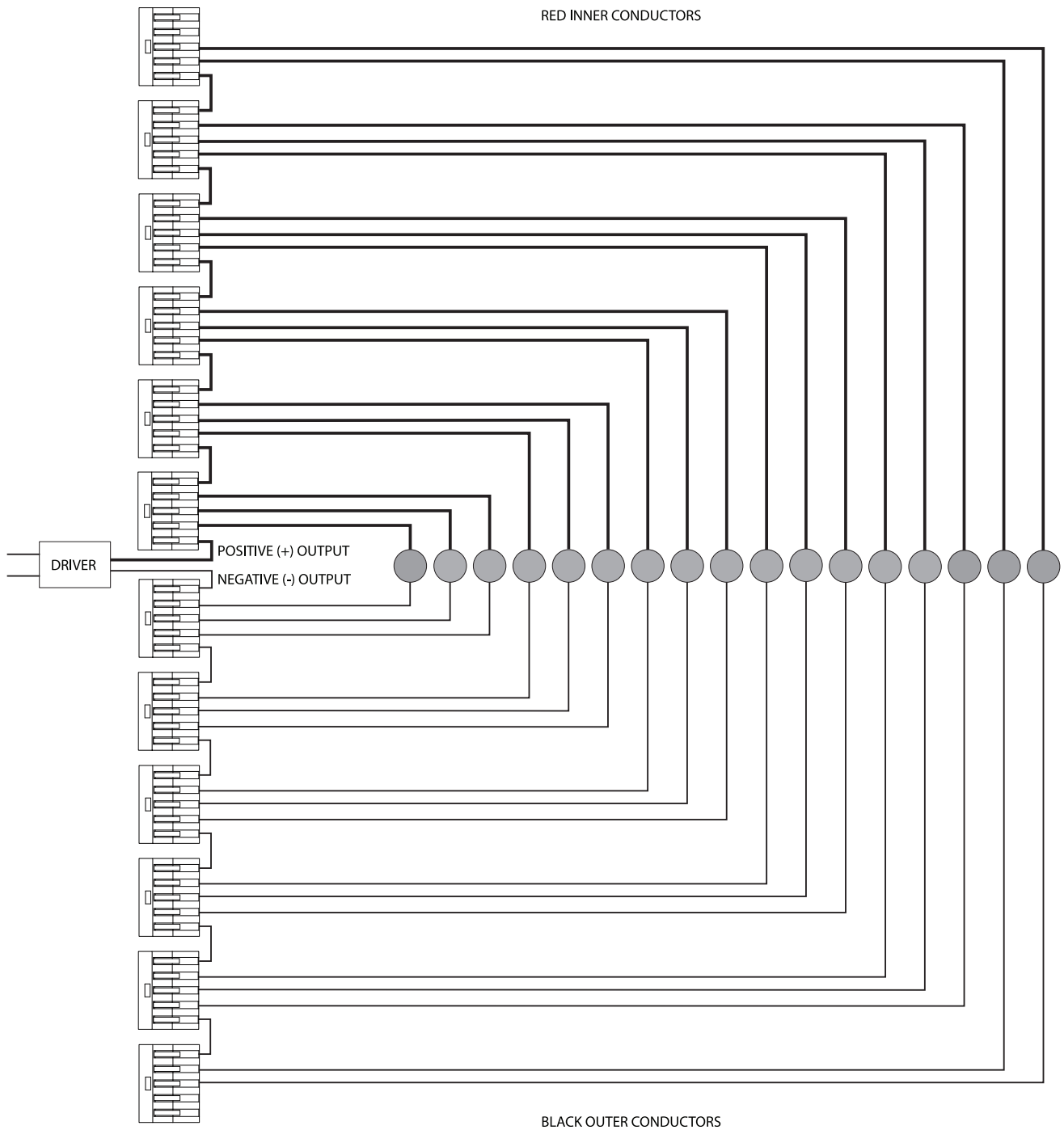

Fig. 4



## Appendix B: Wiring Diagram (For each driver)



## Appendix C: Power Cord Drop Distribution

